



TRUE FOOD SERVICE EQUIPMENT, INC.

St. Charles Industrial Center • P.O. Box 970 • O'Fallon, Missouri 63366
(636)240-2400 • FAX (636)272-2408 • (800)325-6152 • www.truemfg.com

Project Name: _____

AIA #

Location: _____

SIS #

Item #: _____ Qty: _____

Model #: _____

**GDM Series -
Glass Door Merchandisers
(swing door models)**



GDM-49

*TRUE is the world's largest manufacturer of
glass door merchandisers.*

Also available:

- Slide Door Models
- Freezer Models
- Wine Merchandiser
- Rear Load Models
- Ice Merchandisers
- Glass End Merchandisers
- Convenience Store Coolers
- Counter-Top Merchandisers
- Floral Merchandisers
- Radius Front Merchandisers

Remote cabinets and condensing units available for models
GDM-23, GDM-49, and GDM-72.

For other models
remote cabinets available 14% off list
(condensing units supplied by others).

Consult factory technical service dept. for BTU information.

**Glass Door Reach-In Refrigerators
(swing door models)**

- GDM-12, GDM-19, GDM-23,
- GDM-26, GDM-35, GDM-49,
- GDM-72

SPECIFICATIONS / FEATURES

CABINET CONSTRUCTION:

- Durable and permanent non-peel or chip white vinyl exterior.
- White, vinyl coated aluminum interior cabinet liner with 300 series stainless steel floor. Construction of liner in accordance with NSF standards.
- Cabinet mounted on a welded, galvanized frame rail, painted for additional corrosion protection.
- Safety shielded fluorescent interior lighting. Integrated door light standard (except GDM-12).

DOORS:

- Triple pane thermal insulated glass. Doors extend for full view of product. Door gaskets of one piece construction.
- Adjustable, self closing, torsion type closure system. The face of each door fitted with a 12" long handle.

INSULATION:

- Entire cabinet structure insulated using foamed-in-place CFC free polyurethane foam.

SHELVING:

- 4 adjustable vinyl coated wire shelves per door (GDM-12 includes 3 shelves). Shelves capable of supporting up to 250 lbs.
- Full height shelf support pilasters, with double oblong holes on 1/2" centers. Pilasters made of the same material as cabinet interior. Four (4) chrome plated, stainless steel shelf clips to be included for each shelf.

REFRIGERATION SYSTEM:

- Refrigeration system factory balanced using CFC free 134A refrigerant.
- Bottom mounted condensing unit - easy access for maintenance.
- Factory pre-engineered capillary tube system with oversized condenser and evaporator to reduce product pull down time and to consistently maintain 33°F to 38°F interior cabinet temperature. (non-adjustable capillary tube system superior to problematic expansion valve)
- Evaporator - epoxy coated at the time of manufacture to eliminate the potential of corrosion.

ELECTRICAL CHARACTERISTICS:

- Unit completely pre-wired at factory, and ready for final connection to a 115/60/1 phase - 15 amp dedicated outlet. A cord and plug set to be included.
- A sole use circuit is required.



115/60/1
NEMA-5-15R

Specifications subject to change without notice.

Printed in
U.S.A.



APPROVALS:

2/03

Exceptions:



GDM Series: Glass Door Merchandisers - swing door

GDM-12

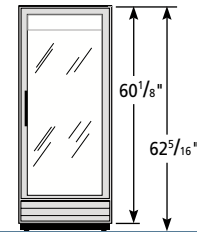
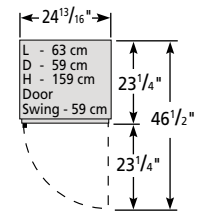

GDM-19

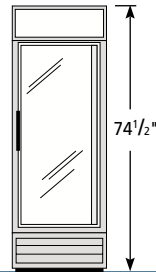
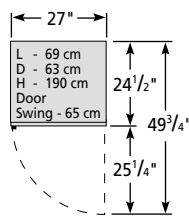

GDM-23

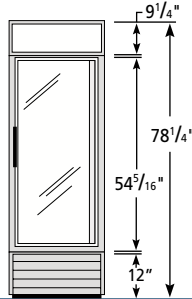
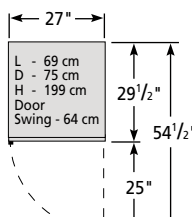

GDM-26

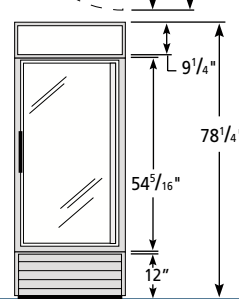
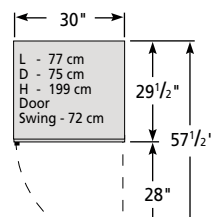

GDM-35

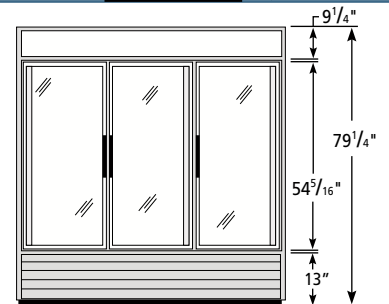
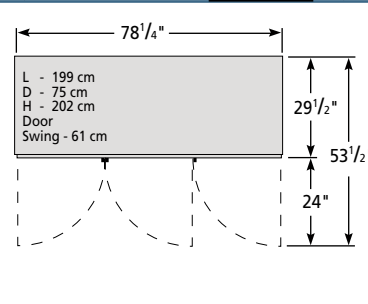
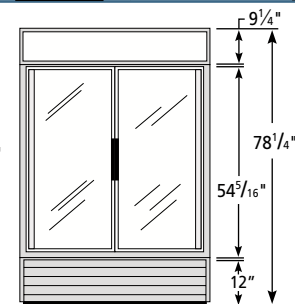
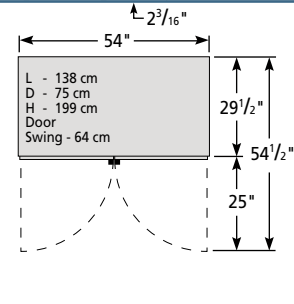
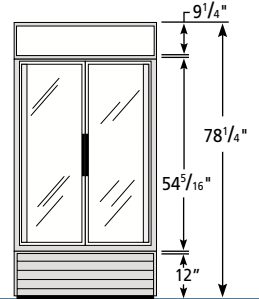
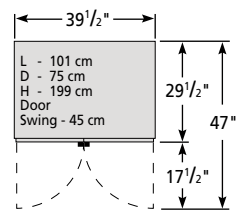

GDM-49

GDM-72

Rough-In Data

Model	Doors	Capacity (Cu. Ft)	# of Shelves	Dimensions (inches)			HP	Volts	PH	Amps	NEMA Config.	Cord Length (feet)	Crated Weight
				L	D ‡	H							
GDM-12†	1	12	3	24 13/16	23	62 5/16	1/5	115	1	5.0	5-15	6	233
GDM-19	1	19	4	27	24 1/2	74 1/2	1/3	115	1	5.0	5-15	9	265
GDM-23†	1	23	4	27	29 1/2	78 1/4	1/3	115	1	7.5	5-15	9	312
GDM-26	1	26	4	30	29 1/2	78 1/4	1/3	115	1	7.8	5-15	9	321
GDM-35	2	35	8	39 1/2	29 1/2	78 1/4	1/2	115	1	9.2	5-15	9	413
GDM-49*	2	49	8	54	29 1/2	78 1/4	1/2	115	1	10.6	5-15	9	472
GDM-72†	3	72	12	78 1/4	29 1/2	79 1/4	1/2	115	1	12.0	5-15	9	660

* Available in Rear Load model
 † Available in Glass End model
 ‡ Depth does not include 1 3/8" for door handle.

Specifications subject to change without notice.

Standard Features

- Oversized and balanced, environmentally friendly 134A refrigeration system - holds 33°F to 38°F.
- White laminated vinyl exterior (rosewood, walnut and black vinyl also available).
- White, vinyl coated aluminum interior and 300 series stainless steel bottom (NSF approved).
- Fluorescent interior lighting (safety shielded).
- Integrated door light (except GDM-12).
- Positive seal, torsion type closure system, self-closing doors.
- Slide out compressor can be serviced easily and accessed by a single repairman.
- Adjustable vinyl coated wire shelves.
- Epoxy coated evaporator.
- Triple pane thermal insulated glass.
- Bottom mount compressor.
- 1 year parts & labor warranty (USA).
- 5 year compressor warranty.
- See our website www.truemfg.com for the latest color & sign offerings.

Optional Accessories

- Gravity-feed TrueTrac® shelving.
- Wine racks.
- Novelty Baskets.
- Additional shelves available.
- GDM-49 available as a rear load model (GDM-49RL).
- Barrel locks available.
- Available with 2 1/2" diameter castors.
- Available with stainless steel or optional seismic legs (excludes GDM-12).
- Remote models available.
- A variety of sign panels available.

Clearance Required For Coolers (USA)

Sides Inches/mm	Top* Inches/mm	Rear Inches/mm
0 / 0	1 / 26	1 / 26

* GDM-12 only

Model	Front				Right				Plan				3D						
	Model	Front	Right	Plan	3D	Model	Front	Right	Plan	3D	Model	Front	Right	Plan	3D				
GDM-12	TFAY55E	TFAY55S	TFAY55P	TFAY553	GDM-35	TFAY17E	TFAY17S	TFAY17P	TFAY173	GDM-19	TFAY19E	TFAY19S	TFAY19P	TFAY193	GDM-23	TFAY23E	TFAY23S	TFAY23P	TFAY233
GDM-26	TFAY09E	TFAY09S	TFAY09P	TFAY093	GDM-49	TFAY03E	TFAY03S	TFAY03P	TFAY033	GDM-72	TFAY01E	TFAY01S	TFAY01P	TFAY013					



TRUE FOOD SERVICE EQUIPMENT

