



3836 SERIES ELECTRIC DECK OVENS



Model EB-1-8-3836



SPECIFICATIONS

BAKERS PRIDE EP-EB-ER Series Electric Deck Ovens are designed for high volume pizza, baking, roasting and all-purpose operations. Interior decks are 36" (915mm) deep and 38" (965mm) wide. Overall dimensions are 43" (1092mm) deep by 55" (1397mm) wide.

Ovens may be stacked three high. Similar footprints may be mixed with different deck heights. Oven exteriors are all heavy-gauge, type 403 stainless steel and are fully insulated up to 5" (127mm) thick for cooler outer temperatures and consistent interior temperatures.

Oven interiors are manufactured of high-heat resistant 18-gauge aluminized steel. Doors are fully insulated, spring balanced with tubular steel handles.

All models feature independent, operator controlled top & bottom heat for perfectly balanced results. Temperature ready indicator lights, moisture control damper and oven interior lights are standard.

EP (pizza) series feature a 300°-680° F (149°-370°C) thermostat, 7" (178mm) interior deck height with Cordierite hearth decks (steel decks optional).

EB (bake) and ER (roast) Series feature 150°-550° F (65° - 288°C) thermostats, a 60-minute electric timer with continuous-ring, audible alarm and manual shut-off. Interior deck heights are available in 8" (203mm) or 12" (305mm). Steel decks standard (optional Cordierite hearth decks reduce deck height by 1" (25mm)).

3836 Models are 8KW and feature 8 electric elements (4 top and 4 bottom). Voltages are available in 208v, 220-240v or 440-480v 1Ø or 3Ø as well as 230-400v in 3Ø with neutral.

1 Year limited part and labor warranty standard.

Job _____ Item # _____

ELECTRIC DECK OVENS



PIZZA

- EP-1-8-3836
- EP-2-8-3836
- EP-3-8-3836

BAKE

- EB-1-8-3836
- EB-2-8-3836
- EB-3-8-3836

BAKE or ROAST

- ER-1-12-3836
- ER-2-12-3836
- ER-3-12-3836

STANDARD FEATURES

- 3836 Models @ 8,000 watts in 208v, 220-240v, 440-480v, 230v or 230-400v
- 300°-680° F (149°-370°C) "Pizza" thermostat
- 150°-550° F (65°-288°C) "Bake & Roast" thermostat
- Infinite Top & Bottom heat controls
- Electric 60-minute timer with continuous ring alarm and manual shut-off on bake & roast models
- Interior oven lights
- Moisture control dampers
- 8" (203mm) or 12" (305mm) Interior deck heights with steel decks and 7" (178mm) or 11" (279mm) interior deck heights in Cordierite
- All stainless steel exteriors
- Aluminized steel interiors
- Spring balanced, fully insulated doors
- Cordierite hearth decks in EP Series
- Steel decks in EB and ER Series
- Fully insulated
- 1 Year limited part and labor warranty

OPTIONS & ACCESSORIES

- Solid state electronic controls with LED display for temperature control and for checking actual temperatures
- Cordierite hearth decks in EB and ER Series — steel decks are recommended for roasting applications
- Steel decks are optional in EP Series
- Choice of thermostat
- Set of 4 casters — two with locks
- Doors with glass window
- Internal steam manifold with individual, adjustable, solenoid controlled steam injectors in each deck — steam source by others
- 5 Hour timer in lieu of 60 minute timer for roasting applications (ER models only)

CERTIFICATIONS



BAKERS PRIDE OVEN COMPANY, INC.
30 Pine Street, New Rochelle, NY 10801
914/576-0200 • 1-800-431-2745 • fax 914/576-0605

Continuous product improvement is a policy of Bakers Pride Oven Company. Therefore, specifications and design are subject to change without notification

TOP VIEW

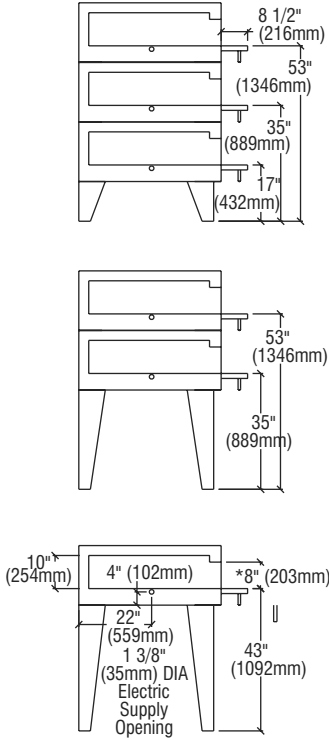
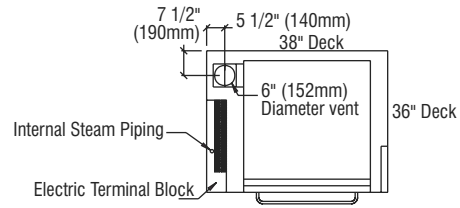
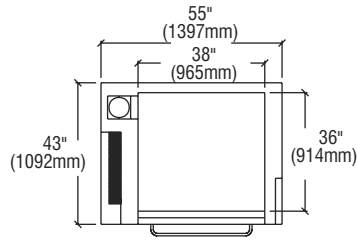

**EP-EB-8-3836
SIDE VIEW**

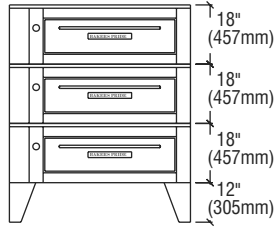

**EP-EB-8-3836
FRONT VIEW**

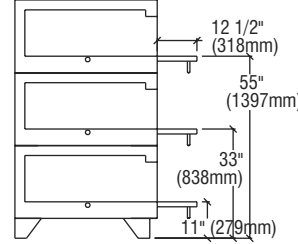
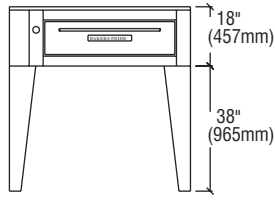
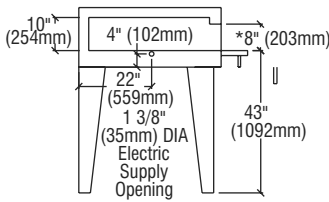
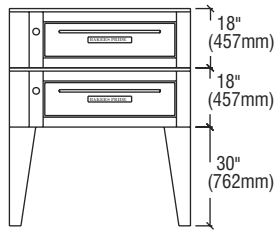
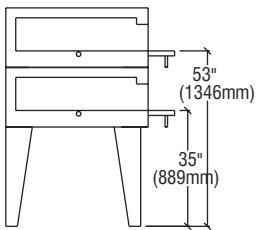

**ER-12-3836
SIDE VIEW**

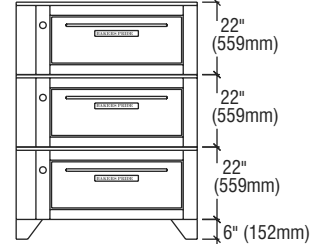

**ER-12-3836
FRONT VIEW**

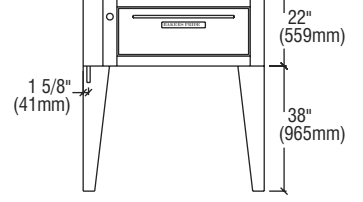
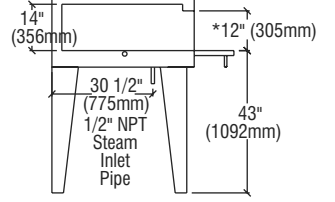
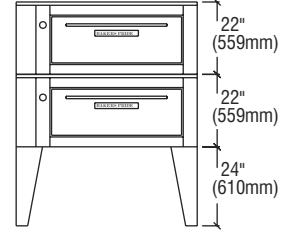
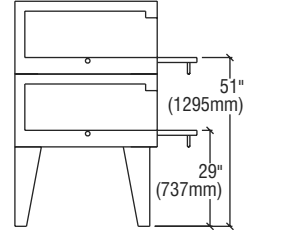

ALL DIMENSIONS NOMINAL

*Steel decks @ 8" & 12" heights — Cordierite decks @ 7" & 11" heights

SHIPPING INFORMATION

Model	Shipping Weight		Carton Dimensions				Crate Size			
	Lbs.	Kilos	Width Inches	mm	Depth Inches	mm	Height Inches	mm	Cubic Feet	Cubic Meter
EP-3836	600	273	60	1524	24	610	48	1219	40	1.1

Under 500 lbs = Shipping Class # 70
Each deck ships separately

POWER SUPPLY

Model	WATTS	VOLTAGE	PHASE	AMPS			
				L1	L2	L3	N
All Models	8,000	208	3	25	25	29	-
	8,000	220-240	3	22	22	28	-
	8,000	208	1	39	39	-	-
	8,000	220-240	1	35	35	-	-
	8,000	230-400	3N	10	14	14	4
	8,000	230	1	35	-	-	35
	8,000	440-480	3	12	12	14	-
	8,000	440-480	1	18	18	-	-

Each deck requires separate electrical connection

SPECIFICATIONS

Model	Deck Size				# Decks	Overall Dimensions					
	Inches	mm	Height Inches	mm		Width Inches	mm	Depth Inches	mm	Height Inches	mm
EP-1-8-3836	38x36	965x914	8	203	1	55	1397	43	1092	56	1422
EP-2-8-3836	38x36	965x914	8	203	2	55	1397	43	1092	66	1676
EP-3-8-3836	38x36	965x914	8	203	3	55	1397	43	1092	66	1676
EB-1-8-3836	38x36	965x914	8	203	1	55	1397	43	1092	56	1422
EB-2-8-3836	38x36	965x914	8	203	2	55	1397	43	1092	66	1676
EB-3-8-3836	38x36	965x914	8	203	3	55	1397	43	1092	66	1676
ER-1-12-3836	38x36	965x914	12	305	1	55	1397	43	1092	60	1524
ER-2-12-3836	38x36	965x914	12	305	2	55	1397	43	1092	68	1727
ER-3-12-3836	38x36	965x914	12	305	3	55	1397	43	1092	72	1829

* Height includes 38" (965 mm) standard legs on single decks
 * Height includes 30" (762 mm) standard legs on double decks with 8" deck heights
 * Height includes 24" (610 mm) standard legs on double decks with 12" deck heights
 * Height includes 12" (305 mm) standard legs on triple decks with 8" heights
 * Height includes 6" (152 mm) standard legs on triple decks with 12" heights

MINIMUM CLEARANCES

	Non-Combustible Construction*		Combustible Construction**	
	Inches	mm	Inches	mm
Left Side	0	0	0	0
Right Side	0	0	0	0
Rear	0	0	0	0

* In European Community Countries and North America. In NON-COMBUSTIBLE locations only.
 ** In European Community Countries only in COMBUSTIBLE locations. NOT for North America.



BAKERS PRIDE OVEN COMPANY, INC.
 30 Pine Street, New Rochelle, NY 10801
 914/576-0200 • 1-800-431-2745 • fax 914/576-0605

Continuous product improvement is a policy of Bakers Pride Oven Company. Therefore, specifications and design are subject to change without notification

TS: 3M 11/04