



T&S BRASS AND BRONZE WORKS, INC.
 2 SADDLEBACK COVE / P.O. BOX 1088 / TRAVELERS REST, SC 29690
 PHONE 800-476-4103 - FAX 864-834-3518



Model No.

MV-2516-24

**RELIABILITY
 BUILT IN**

Job Name:

Architect/Engineer Approval:

Notes:

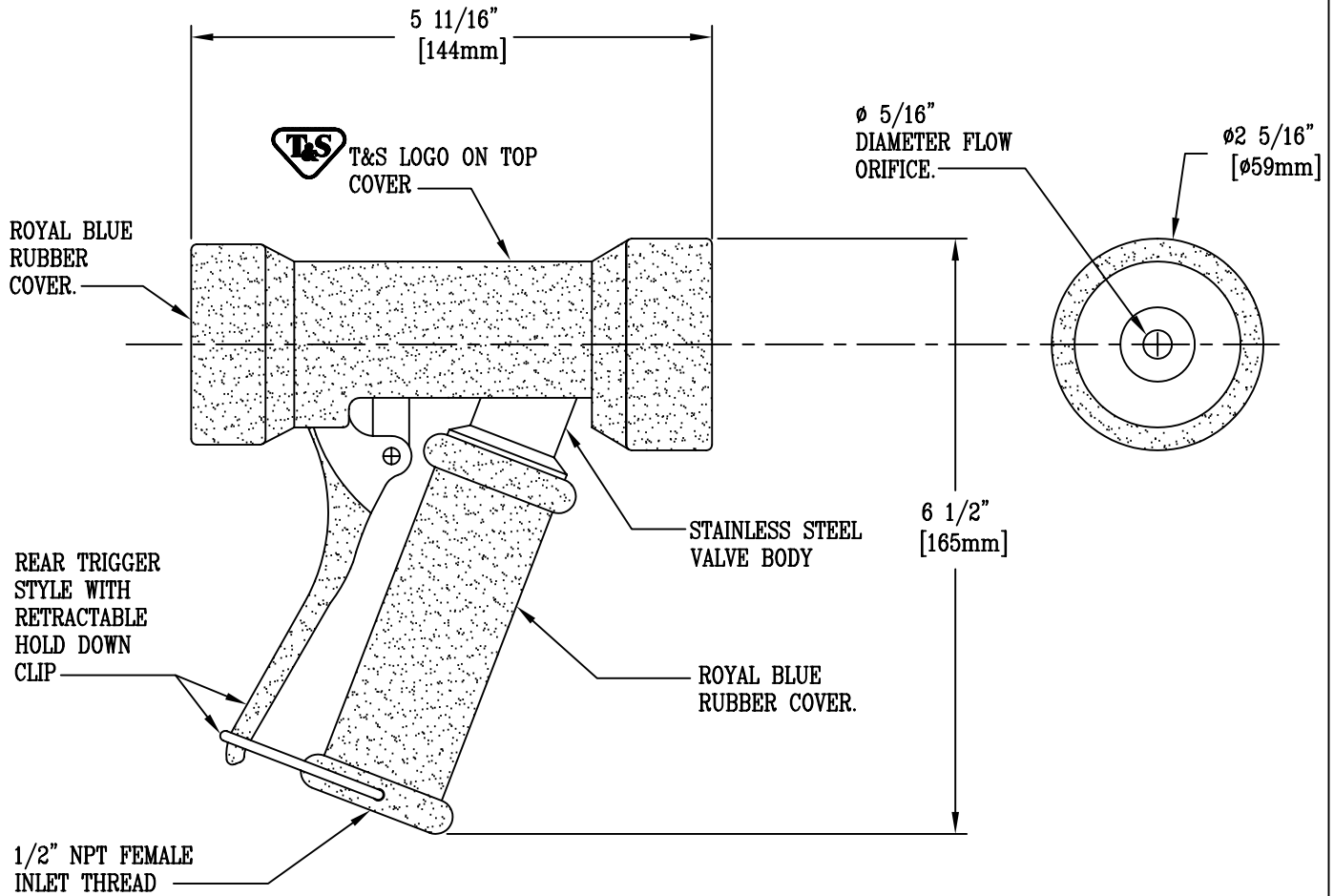

Product Description:

STAINLESS STEEL WATER GUN, REAR TRIGGER,
 5/16" FLOW ORIFICE, RUBBER COVER.

Drawn:

LEL

Approved

MVW

Checked

JKD

Scale:

1 : 2

Date:

12/12/02