



PROJECT	
ITEM #	
QUANTITY	DATE
APPROVAL	

N8100-FA

Drop-In Self-Contained Forced Air Refrigerated Cold Pans

Short Form Specifications

Top: is one-piece 20-gauge stainless steel. Interior liner is 22-gauge stainless steel and is creased to 1" I.P.S. (2.54cm) diameter drain. A stainless steel bracket, flush with the top, for pans to accommodate 12" x 20" (30.5cm x 50.8cm) pans 4" (7.6cm) deep supplied by others. Product temperatures of 33°F (1°C) to 41°F (5°C) are maintained at 86°F (30°C) ambient room temperature, meeting NSF 7 requirements. Adapter bars are standard.

Sides and bottom: are insulated with high-density closed-cell polyurethane. Exterior housing is 24-gauge galvanized steel.

Refrigeration: system uses HFC-404A refrigerant. Condensing unit is suspended below the cold pan on a 16-gauge steel frame. Temperature control has an OFF position to shut down the cold pan. Unit is supplied with expansion valve. Evaporator coil cools pans by air flowing over and under pans. A stainless steel louver is provided for field installation; cutout dimension is 11" x 22" (27.94cm x 55.88cm). A second opening at the rear of the cabinet should be provided at installation to allow for proper air circulation.

Air Curtain assembly is removable without the use of tools.

Electrical system is 115/60c/1ph with NEMA 5-15 plug on the 8131-FA, 8144-FA and 8157-FA models. The 8169-FA and 8182-FA models come with a NEMA 5-20 plug.

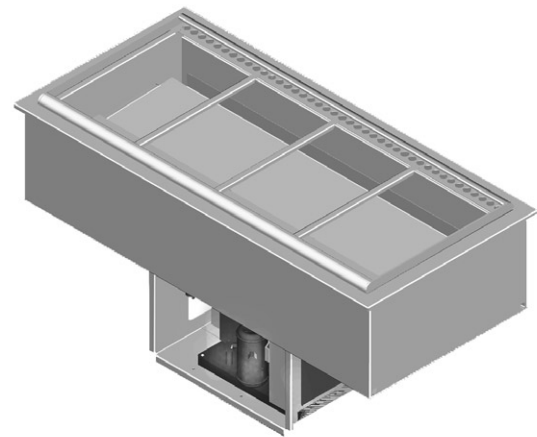

Model N8157-FA

Optional Accessories and Modifications:

- Custom sizes and styles
- Single or double service flip-up sneezeguards
- Relocate compressor
- Remote refrigeration (specify refrigerant)



Drop-In Self-Contained Forced Air Refrigerated Cold Pans

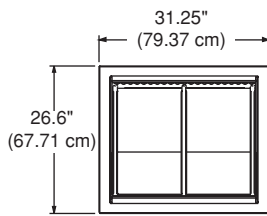

**PLAN VIEW
N8131-FA**

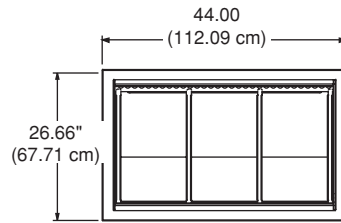

**PLAN VIEW
N8144-FA**

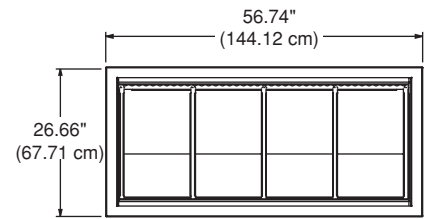

**PLAN VIEW
N8157-FA**

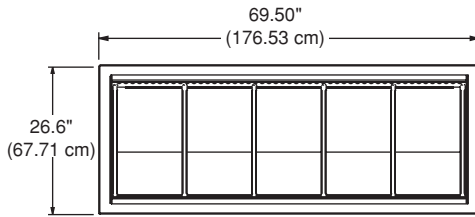

**PLAN VIEW
N8169-FA**

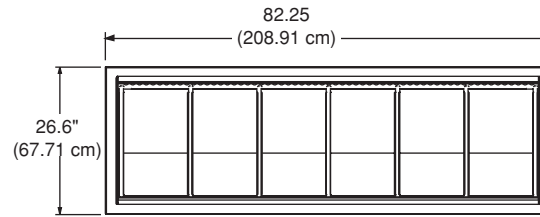

**PLAN VIEW
N8182-FA**

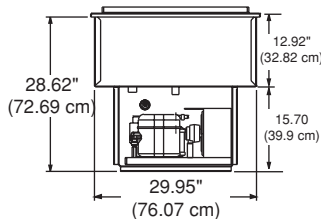

**ELEVATION VIEW
N8131-FA**

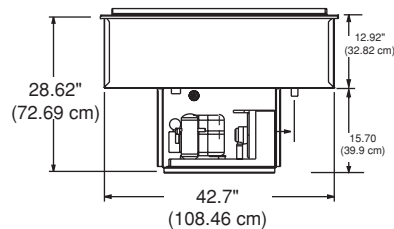

**ELEVATION VIEW
N8144-FA**

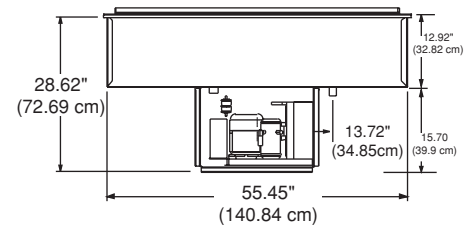

**ELEVATION VIEW
N8157-FA**

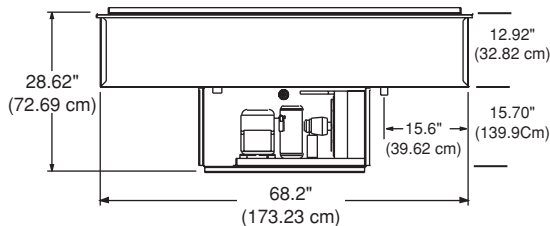

**ELEVATION VIEW
N8169-FA**

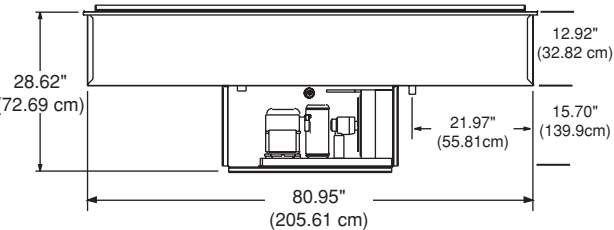

**ELEVATION VIEW
N8182-FA**

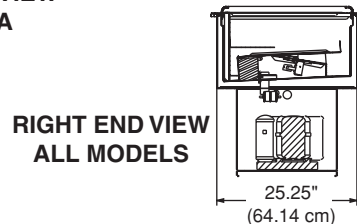

**RIGHT END VIEW
ALL MODELS**

Mechanical Data — Standard Unit

MODEL NUMBER	COUNTER CUTOUT DIMENSIONS	# OF 12" X 20" PANS HELD	VOLTS/HERTZ/PHASE	AMPS	H.P.	NEMA PLUG	SHIP WEIGHT LBS/KG
N8131-FA	30.25 x 25.5" (76.71cm x 64.77cm)	2	115/60/1	8.0	1/4	5-15P	165/75
N8144-FA	43.00" x 25.5" (109.09cm x 64.77cm)	3	115/60/1	10.0	1/2	5-20P	175/79
N8157-FA	55.75" x 25.5" (141.48cm x 64.77cm)	4	115/60/1	10.0	1/2	5-20P	225/102
N8169-FA	68.50" x 25.5" (173.86cm x 64.77cm)	5	115/60/1	15.0	3/4	5-20P	235/106
N8182-FA	81.25" x 25.5" (206.25cm x 64.77cm)	6	115/60/1	15.0	3/4	5-20P	255/116